

INDIVIDUAL OFFSHORE SOLUTIONS  
FOR THE WIND POWER INDUSTRY





## LICHTGITTER – ABOUT US

### A BRIGHT OUTLOOK SINCE 1929

Lichtgitter was established in 1929 in order to carry out the specialized manufacturing of gratings. By the continuous monitoring of our performance, and quality systems, together with innovation in manufacturing techniques, we have ensured Lichtgitter's place in the forefront of manufacturers of industrial floor coverings with subsidiaries all over the world. Besides the production of pressure-locked

gratings, forge-welded gratings and perforated metal planks, a various offer of GRP products are part of the production range. Our current product range also includes profiled chequer plates, spiral staircases, stairtreads and ladder rungs. Together with our steel slitting service centre and hot dip galvanizing plants we provide a complete fabrication facility to our customers.

## LICHTGITTER OFFSHORE

WE ARE EXPERIENCED IN THE HIGH DEMANDS OF OFFSHORE CONSTRUCTION AND THE REQUIREMENTS TO ENSURE ON-TIME DELIVERIES, TO ENABLE TIGHT PROGRAMMES TO BE MET.

THIS CHALLENGE TO ENSURE EXCEPTIONAL QUALITY AND LOGISTICAL NEEDS IS WHERE LICHTGITTER SCORES WITH FULLY INTEGRATED SERVICE OF PRODUCTS AND SYSTEMS.

Our computer supported CAD/CAM production and manufacturing system grant high quality and satisfied customers.

True to the motto 'Lichtgitter – Everything from one source' we offer you the range to meet your wind energy plant requirements with all types of industrial floor coverings. Whether platforms of gratings or chequer plates or trans-former coverings to the point of helihoist, we give you an

all-inclusive package backed-up by the established Lichtgitter quality. Due to our long lasting experience you can be assured that we will ensure quality and safety at all levels. The advantage of our complete offering is that you can discuss everything with one supplier and that you get all the product-related services like support during the planning period, preparation of layout-drawing, completion of the technical documentation from one source.

## PRODUCT VARIETY OF LICHTGITTER:

## EVERYTHING FROM ONE SOURCE. AND WHAT CAN WE DO FOR YOU?

### GRATINGS

In addition to forge-welded gratings, which are characterized by an excellent loadbearing capacity and torsional rigidity coupled with a non-slip factor due to the twisted cross bars, Lichtgitter also produces a lot of types of pressure-locked gratings. Pressure-locked gratings are made of steel, stainless steel and aluminium.

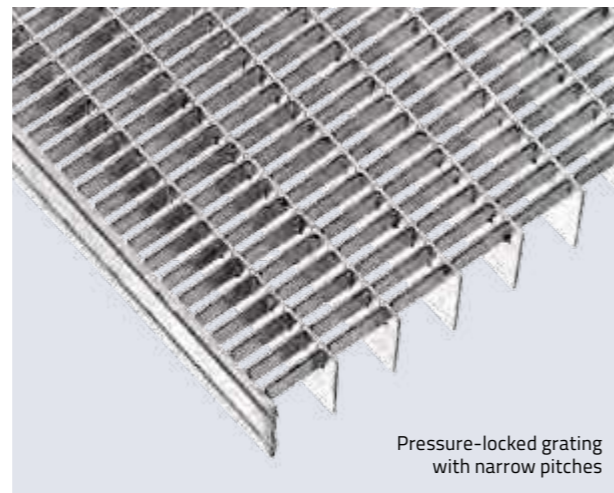
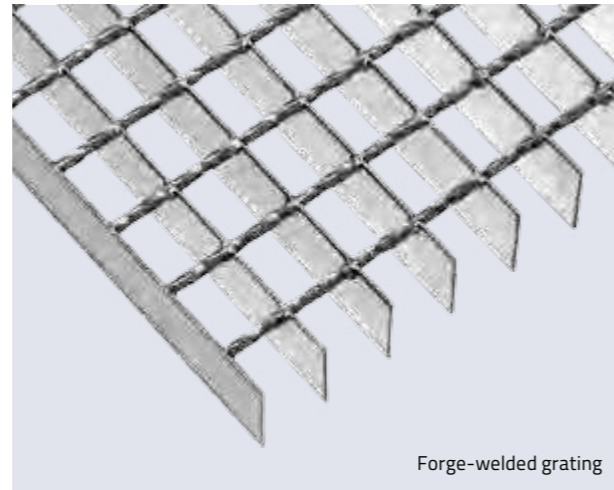

### CHEQUER PLATES

Chequer plates are often used in the offshore area as a floor covering. Due to the structure the flooring with its closed surface is slip resistant even in presence of oil and grease. The rate of wear seen over years is relatively low.

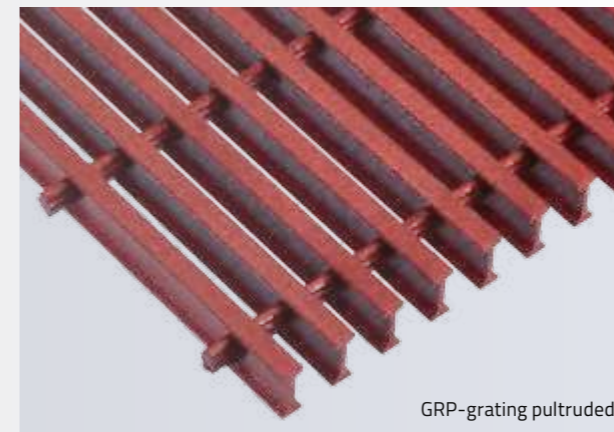
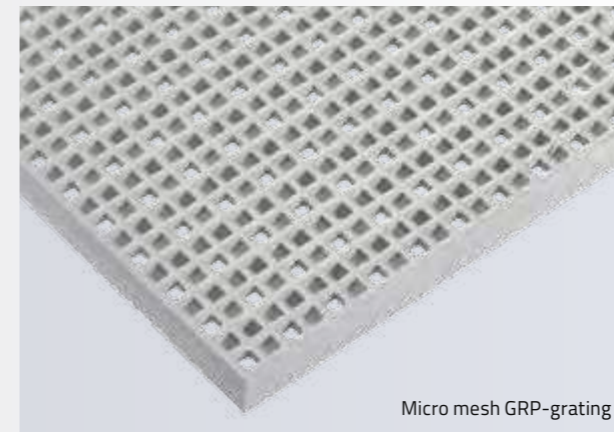
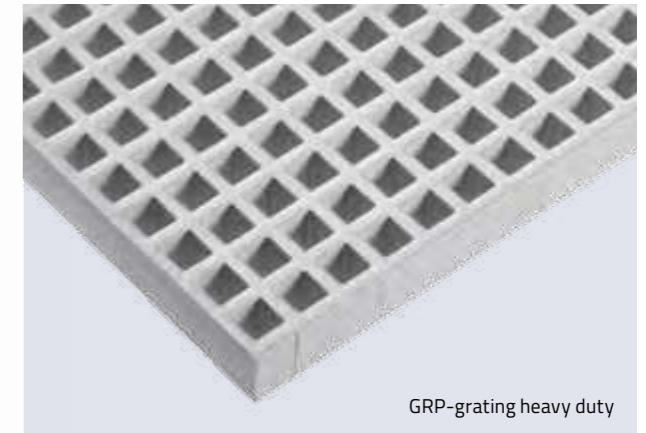
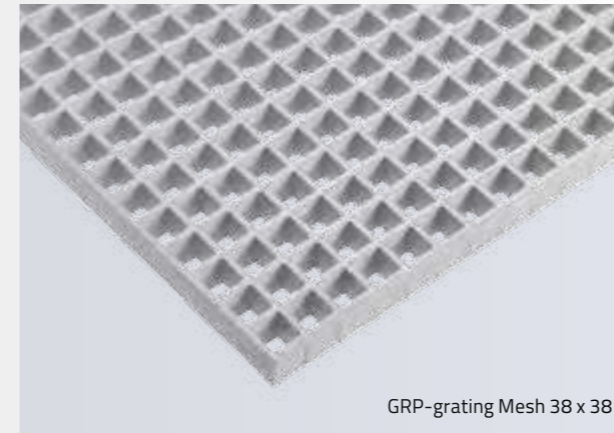
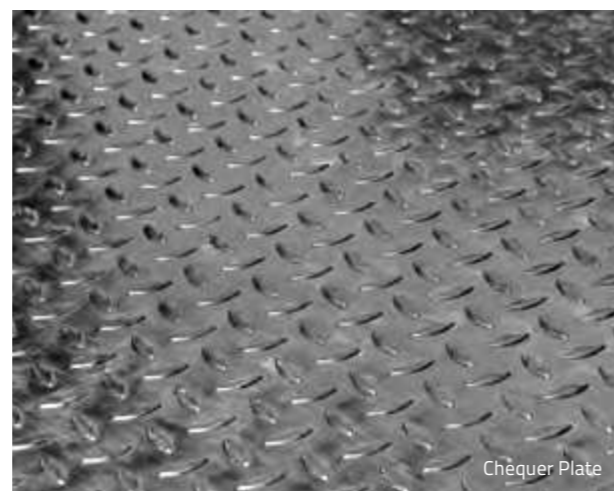

### GRP-GRATINGS

The Lichtgitter Group has produced and distributed a range of GRP-gratings since the early 90s. The GRP-gratings are especially used as floor coverings in the offshore area due to their corrosion resistance and long durability. GRP-gratings are easily adaptable to complex structures and shapes also the ability to achieve a serration class R13 according to BGR 181. Another advantage of GRP-products is the low weight to span ratio.

### PERFORATED METAL PLANKS

Perforated metal planks distinguish themselves by providing a high level of slip resistance and comfort to standing areas. Large spans can be achieved, thus minimizing the use of steel substructures. Perforated metal planks can be manufactured in variety of surface patterns. The flame resistant covering BN-OF is based on the perforated metal plank type BN-O and is used as a transformer covering on transformer stations.

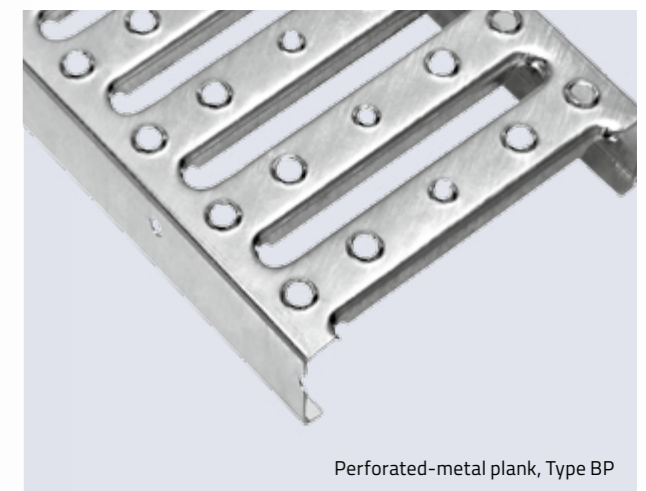

# LICHTGITTER OFFSHORE- SOLUTIONS AT A GLANCE:

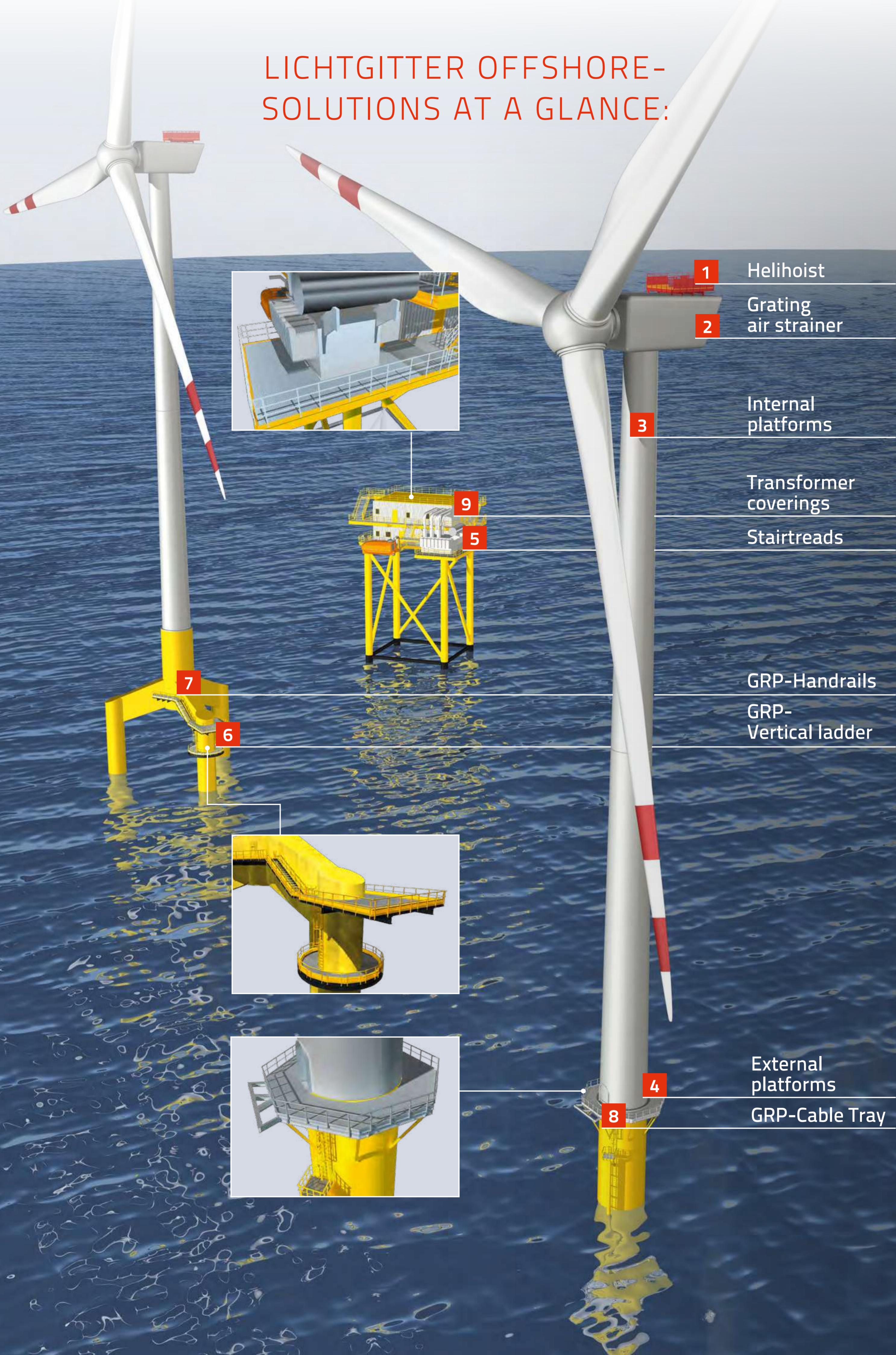

1

Helihoist

2

Grating  
air strainer

3

Internal  
platforms

9

Transformer  
coverings

5

Stairtreads

7

GRP-Handrails

6

GRP-  
Vertical ladder

4

External  
platforms

8

GRP-Cable Tray

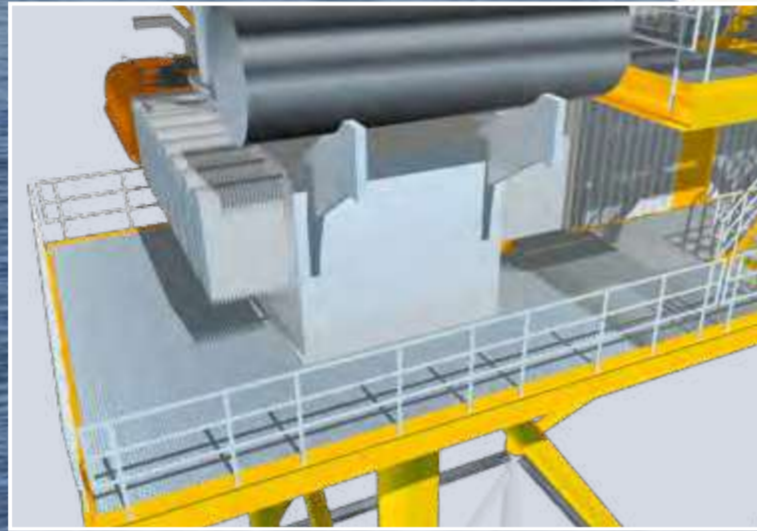

## 1. HELIHOIST

The helicopter platforms are made of GRP-gratings and – profiles. Even at poor weather conditions it is possible to set up persons via helicopter. The platforms are distinguished not only for the usual properties of GRP-products, they have a low maintenance and high durability too. Furthermore solutions concerning the static charge are available.

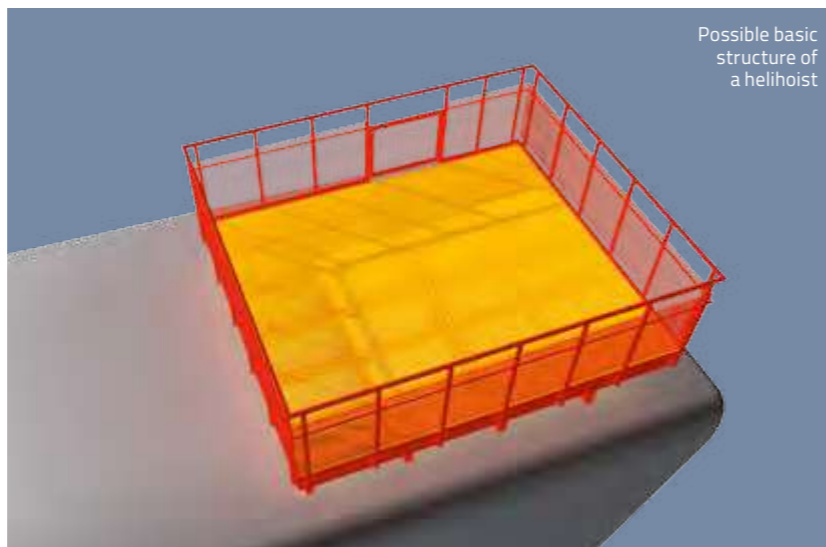

## 2. GRATING

### AIR STRAINER

For the cooling of the oil inside the engine room, air from the environment is running via an air strainer to the oil cooler. With the help of a special "sandwich" flooring of duplex coated pressure-locked gratings it is possible to get access and to maintain the units. Filter fleece and counter bearings are within a single component. The filter can be replaced relatively easily without additional safety measures. This reduces the maintenance costs.

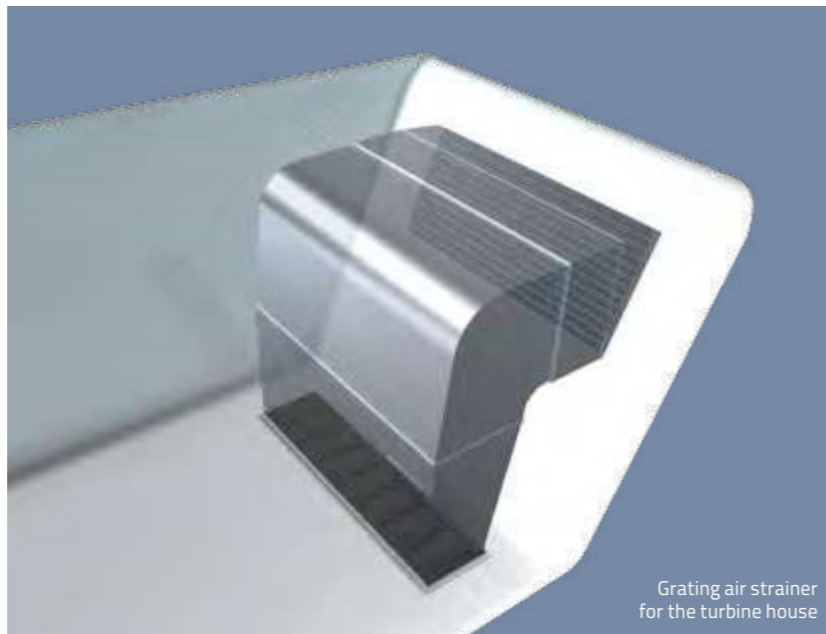

## 3. INTERNAL PLATFORMS

The internal platforms in the tower of the windmill can be arranged with different floorings. Industrial floor coverings are specially qualified for this. In addition to the established range of gratings like forgewelded gratings and pressure locked gratings in steel, stainless steel and aluminum, we also can supply perforated metal planks in a variety of surface patterns, GRP-gratings or chequer plates.

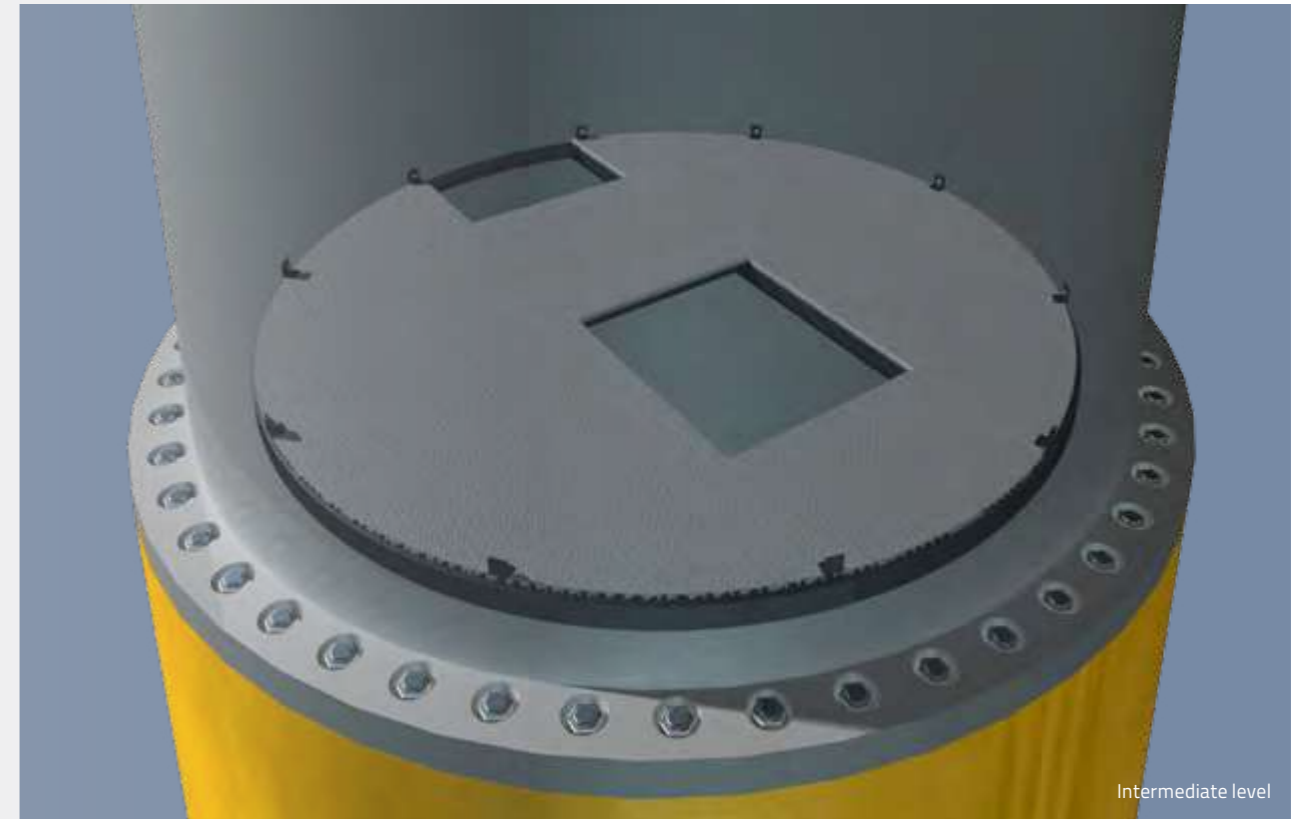

#### 4. EXTERNAL PLATFORMS

The external platform is located at the bottom of the windmill and is used for parking of containers and materials which are needed for maintenance.

On this maintenance platform different floorings can be used. Often used are gratings made of fiberglass plastic. In addition to GRP-gratings, GRP-handrails and GRP-cable trays can be applied. They are characterized by their weather resistance and their low weight.

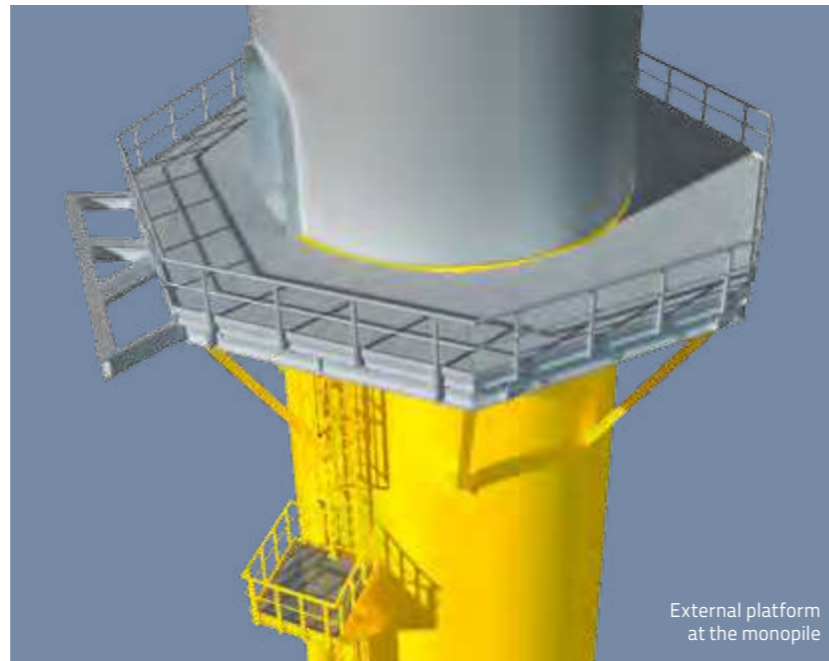

External platform at the monopile



External platform at the tripile

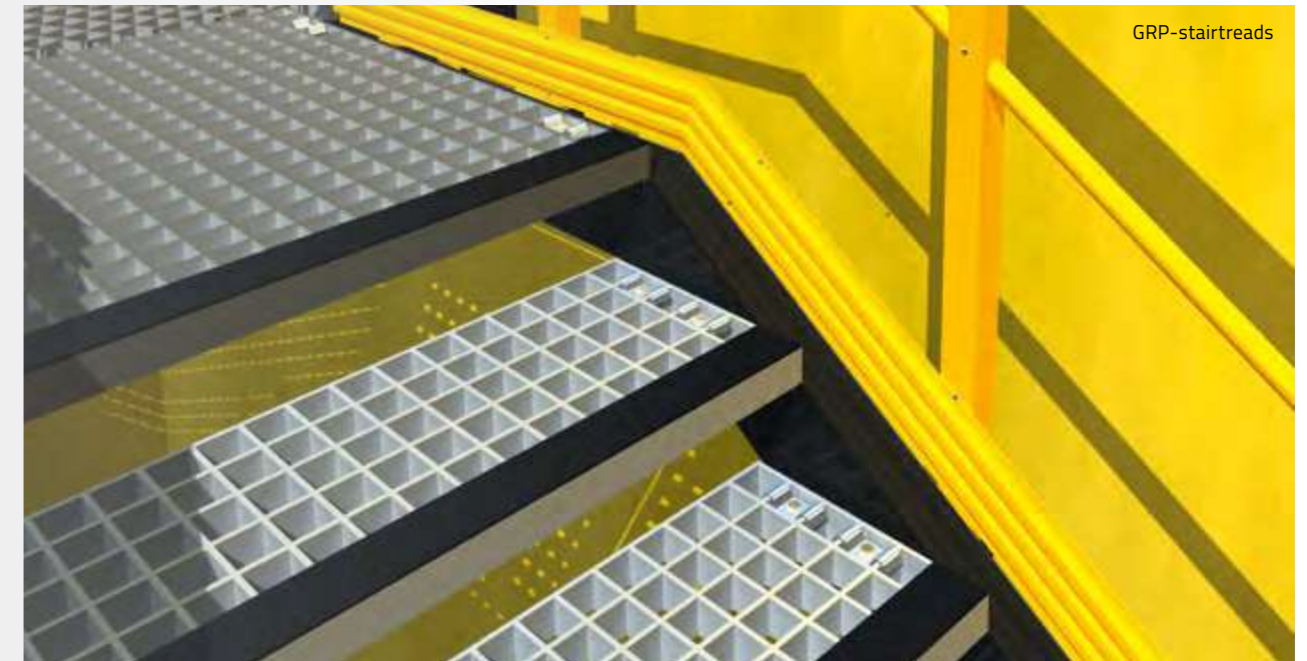

GRP-stairtreads

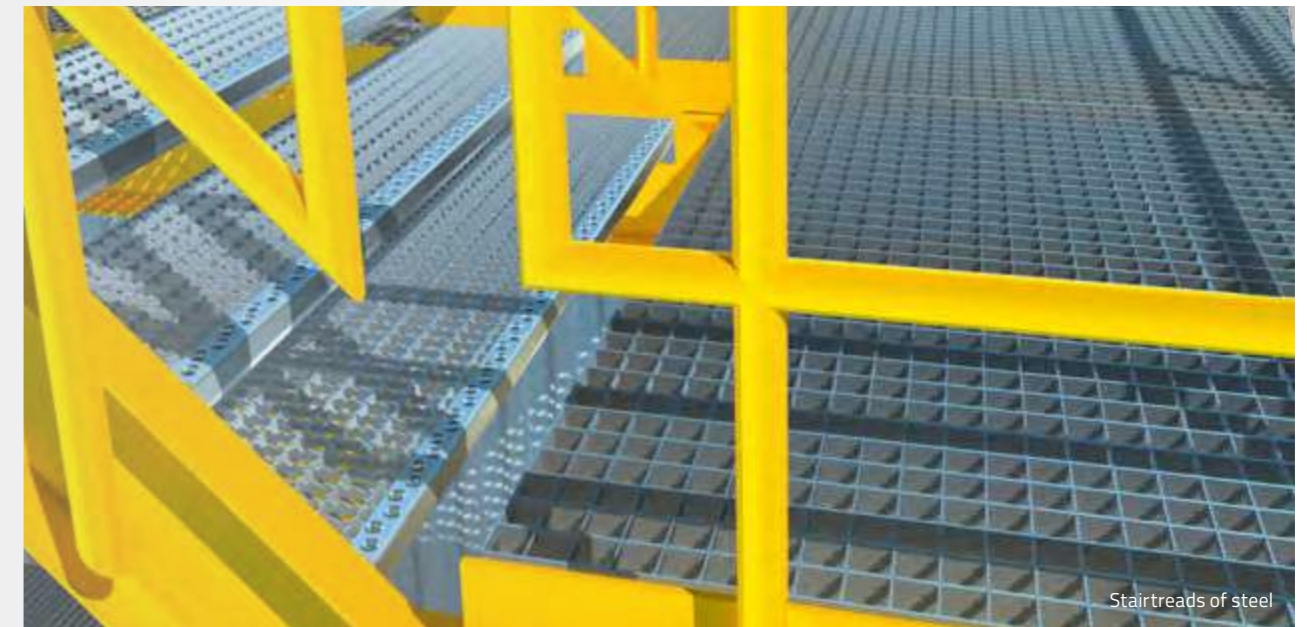

Stairtreads of steel

#### 5. STAIRTREADS

Pressure-locked-, forge-welded-, perforated metal planks- and GRP-stairtreads are produced in the same grating types as used for platforms and walkways.

Stairtreads of steel are always supplied with serrated, perforated nosing and welded side plates. Perforated nosing increases the anti-slip value of the stairtreads and

favourably accentuates the leading edge visually. This is an important contribution to safety. GRP-stairtreads are supplied with a closed, black gritted nosing or with a GRP black gritted angle as nosing for static requirements. GRP-stairtreads will normally be supplied without side plates. It is possible to deliver the stairtreads with a side plate made of GRP-angle if required.



## 6. GRP- VERTICAL LADDER

Lichtgitter GRP-Vertical ladders are weather resistant and have durability and light weight. They are made of GRP-profiles according to EN 13706, type E23. The rungprofile (ladder step profile) is slip resistant. At the screwing points of the rungs the GRP-Vertical ladder will be reinforced by PE materials.

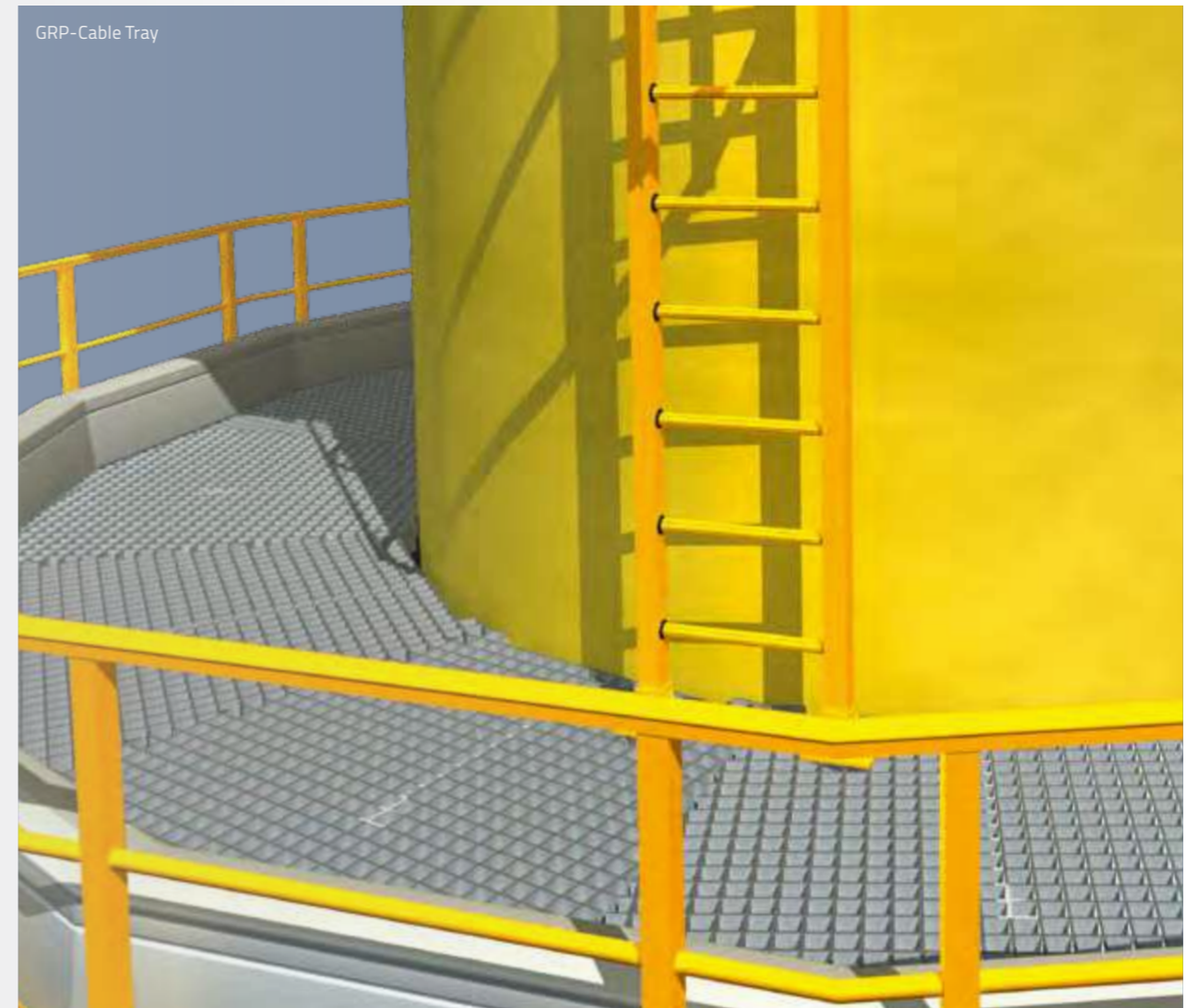

## 8. GRP-CABLE TRAY

Lichtgitter Cable trays are manufactured on the basis of a high grade resin, strengthened with glass fibres and are weather resistant. They are UV-resistant and have good properties in relation to fire classification. Because of their closed system, they provide good protection for the cables to media and weather influences. Other advantages of the cable channel system are its low weight and the easy handling and processing of the profiles.

## 7. GRP-HANDRAILS

Lichtgitter GRP handrails are produced from GRP profiles reinforced with glass fibre. They can withstand high loads, are weather resistant and easily to assemble and fit. They can be provided both as horizontal as well as an inclined handrailing system.

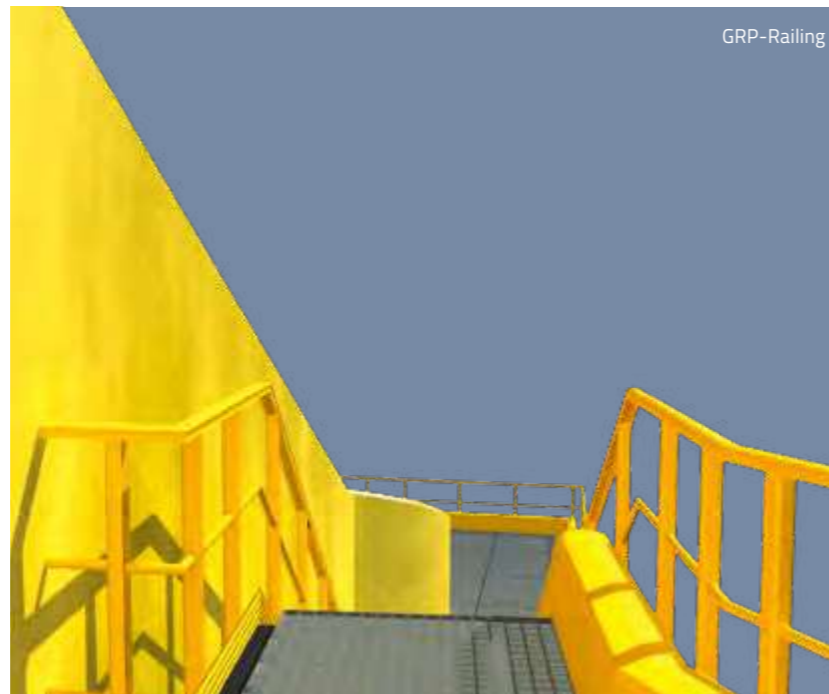

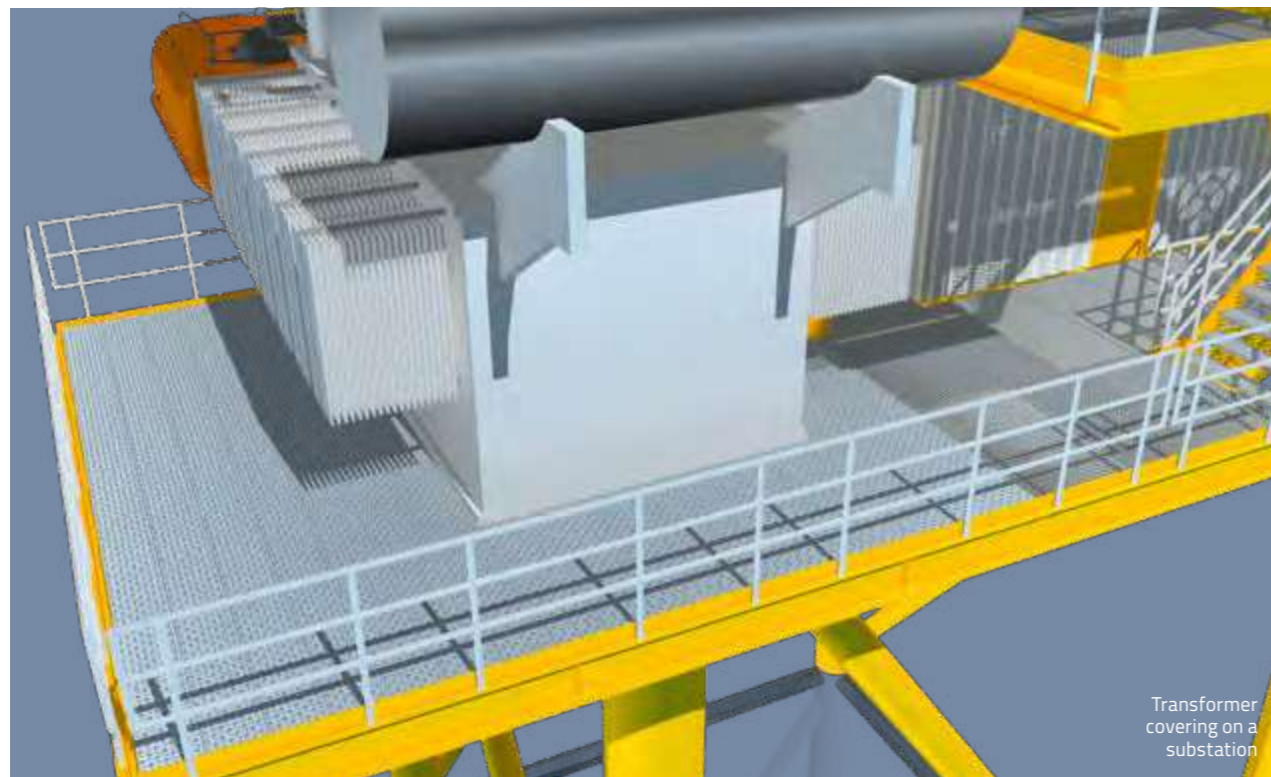

Transformer covering on a substation

## 9. TRANSFORMER COVERINGS

The flame resistant covering BN-OF has gained acceptance as an alternative to the conventional transformer covering with coarse gravel. Due to the limited air permeability the flames are contained and delayed in case of a brand. Even for the transformer in the offshore area the flame resistant covering, which is based on the perforated metal plank type BN-O, form an optimal solution. The BN-O planks have an optimal surface structure and are slip resistant up to the serration class R11 according to BGR

181 due to the unique punched hole pattern. The hole pattern allows an optimal flow rate of oil, fire and rain water. The covering can be assembled and dismantled quickly, because of its low weight. So, maintenance costs and switch-off costs for the required inspections and closeness tests can be reduced.

## SERVICE



WITH THE HELP OF OUR SERVICES WE ENABLE YOU TO REACH YOUR TARGETS. WE OFFER A COMPETENT PRODUCT- AND BUILDING-LINKED ADVICE IN COMBINATION WITH HIGH TECHNICAL KNOW-HOW AND EXPERTISE.

For us it is a great pleasure to get inquiries which request individual demands and therefore lead to the developing of new application solutions. We offer support regarding the planning, preparation of layout drawings, design and technical documentation. The preparation of packing lists as well as an appropriate packaging and consignment are also part of our services.

To ensure the high quality of our service the manufacturing of our products is monitored and assessed in accordance with all important standards and regulations. So you can rely on our market leading quality standards and many years of experiences as well as on the excellent competence and reliability of your contact persons.

### YOUR ADVANTAGES

- + Technical advice on the calculation and selection of our different products
- + Preparation of auditable static verification
- + Providing of tender documents
- + Preparation of installation plans
- + Production of 2D- and 3D drawings
- + Assembly for testing reasons at works
- + Appropriate packaging and consignment
- + Participation in national / international associations and committees to set rules and regulations



## EVERYTHING FROM ONE SOURCE:

forge-welded gratings, pressure-locked gratings,  
perforated metal planks, GRP-gratings,  
chequer plates, spiral staircases, stairtreads,  
ladder rungs, hot-dip galvanising, steel service

### Lichtgitter GFK GmbH & Co. KG

Siemensstraße 1  
D-48703 Stadtlohn  
Fon +49.2563.911-0  
Mail [info@lichtgitter.com](mailto:info@lichtgitter.com)

### Lichtgitter GmbH

Siemensstraße 1  
D-48703 Stadtlohn  
Fon +49.2563.911-0  
Mail [info@lichtgitter.com](mailto:info@lichtgitter.com)

### Lichtgitter Blechprofilroste GmbH & Co. KG

Neckarwiesen 20  
D-72172 Sulz | Neckar  
Fon +49.7454.9582-0  
Mail [sulz@lichtgitter.com](mailto:sulz@lichtgitter.com)

### Lichtgitter Treppen GmbH & Co. KG

Schönower Straße 6  
D-16306 Casekow-Blumberg  
Fon +49.33331.797-0  
Mail [blumberg@lichtgitter.com](mailto:blumberg@lichtgitter.com)