

bovenzijde rooster

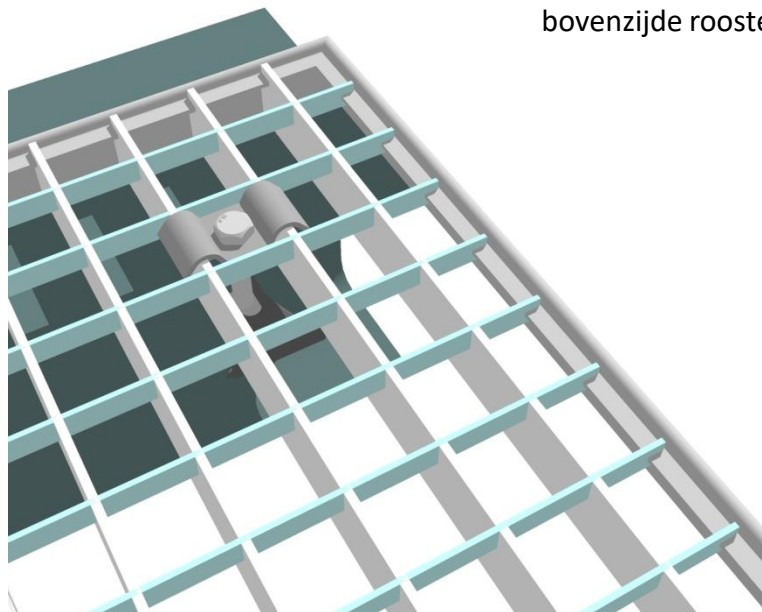

onderzijde rooster

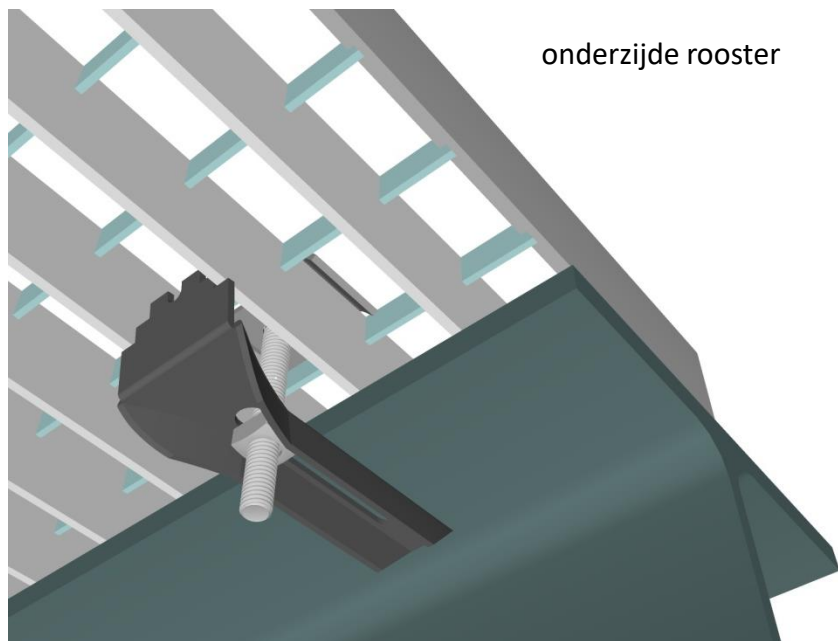

Productomschrijving Standaard:

Type: Persrooster

Materiaal: St235JR

Zadel: afhankelijk van de maas

Zeskant bout: M8

Kikker: afhankelijk van de maas

Vierkant moer: M8

bovenzijde rooster

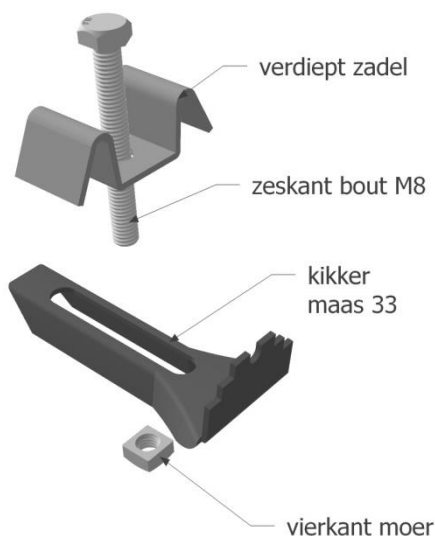
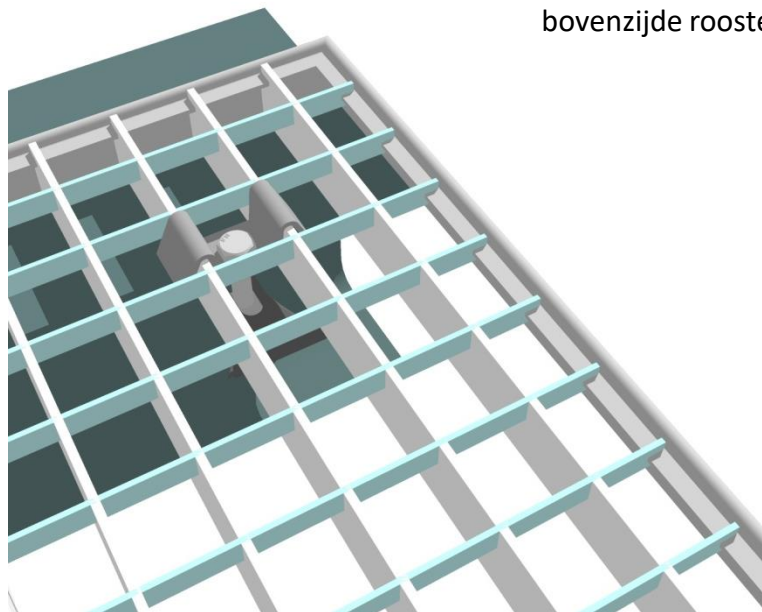

onderzijde rooster

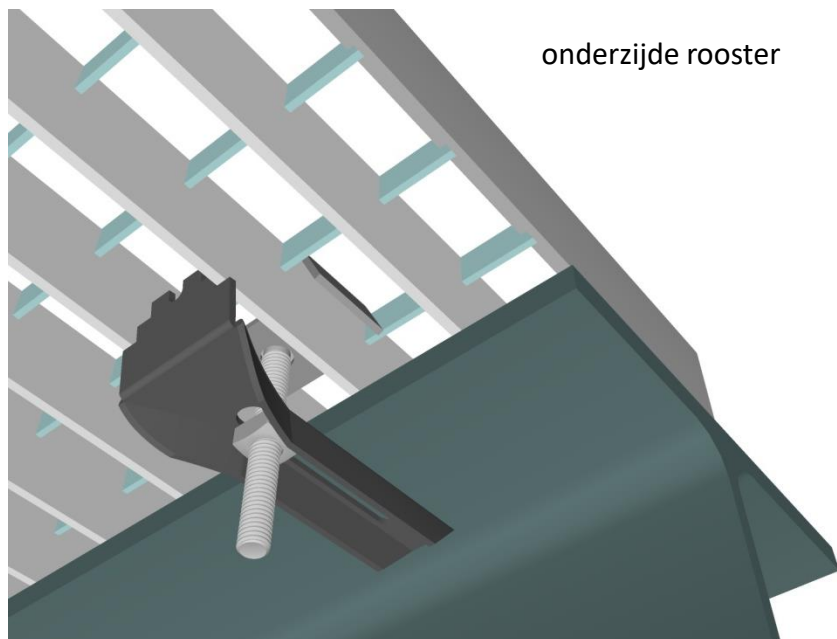

Productomschrijving verdiept zadel:

Type: Persrooster
Maas: 33.33x33.33
Materiaal: St235JR

Zadel: verdiept zadel maas 33
Kikker: kikker maas 33

Zeskant bout: M8
Vierkant moer: M8

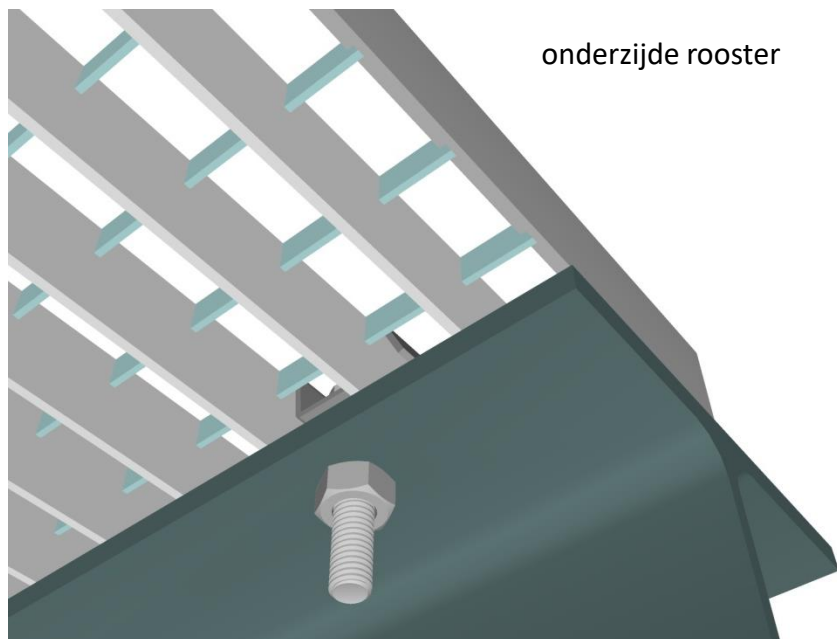
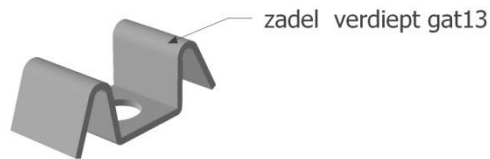
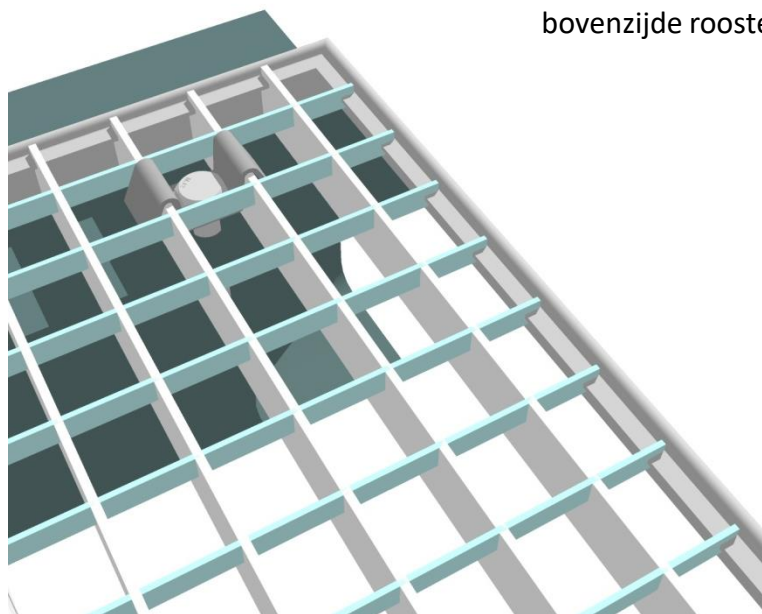

Productomschrijving verdiept zadel gat \varnothing 13mm:

Type: Persrooster
Maas: 33.33x33.33
Materiaal: St235JR

Zadel: verdiept zadel maas 33 gat \varnothing 13

bovenzijde rooster

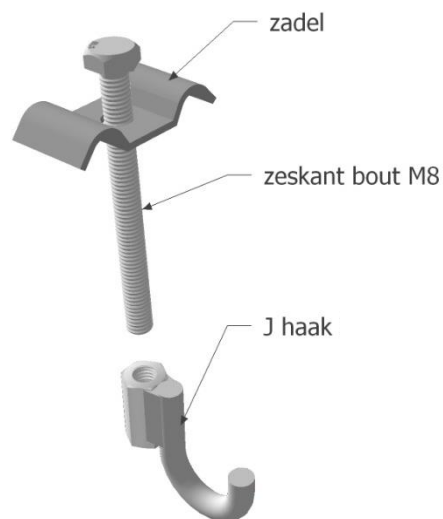
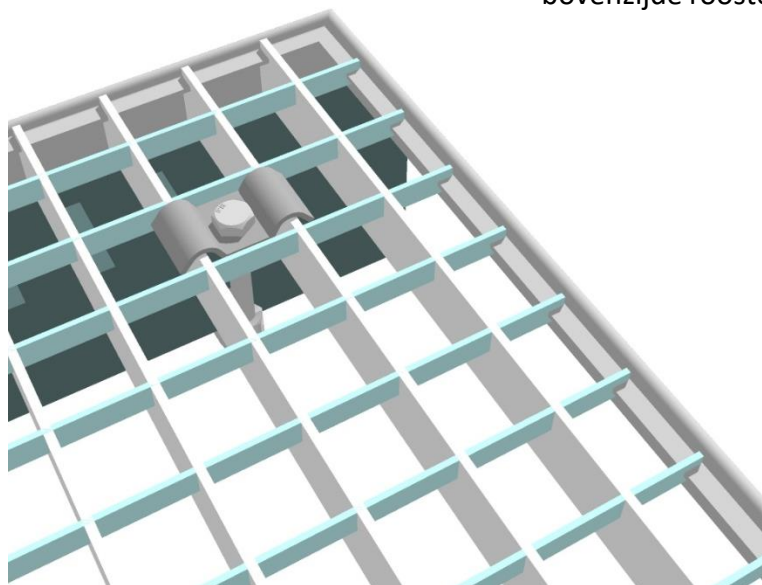

onderzijde rooster

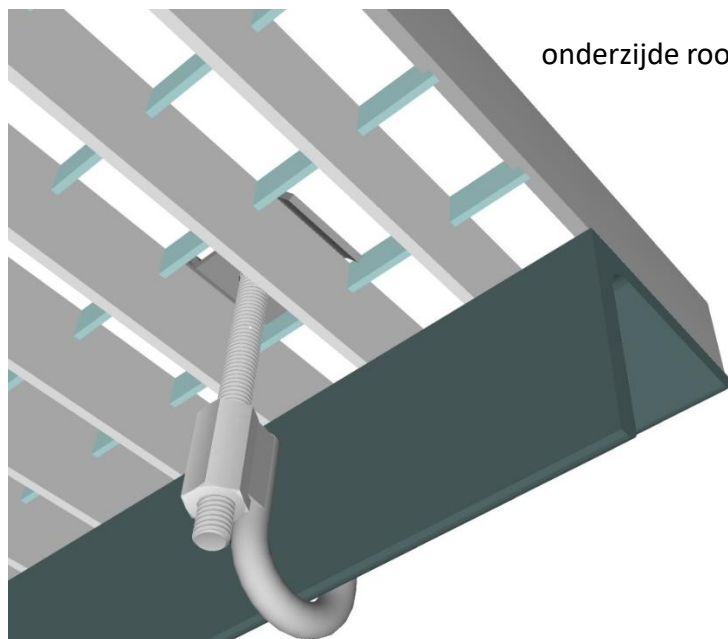

Productomschrijving J-haak:

Type: Persrooster
Maas: n.v.t.
Materiaal: St235JR

Zadel: afhankelijk van de maas Zeskant bout: M8
J haak: 35 of 60 hoog

bovenzijde rooster

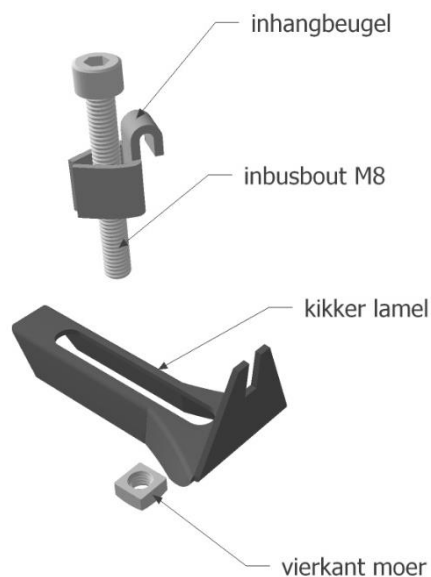
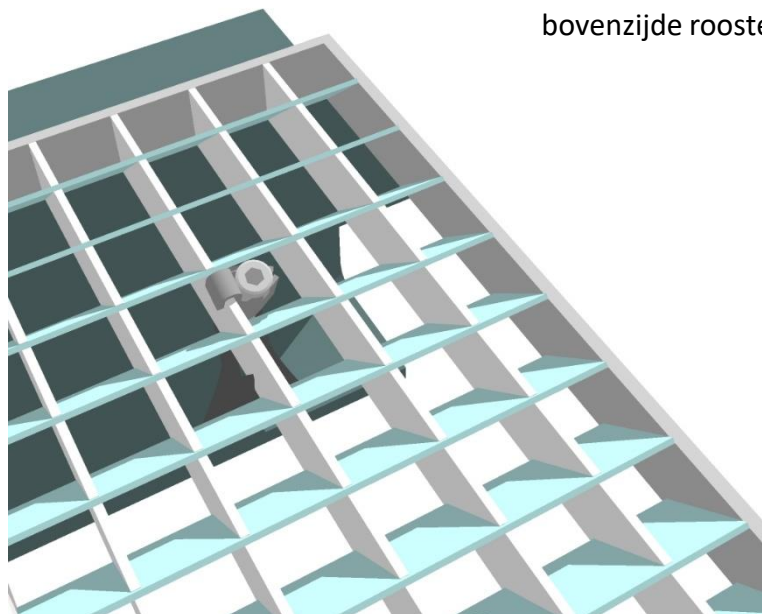

onderzijde rooster

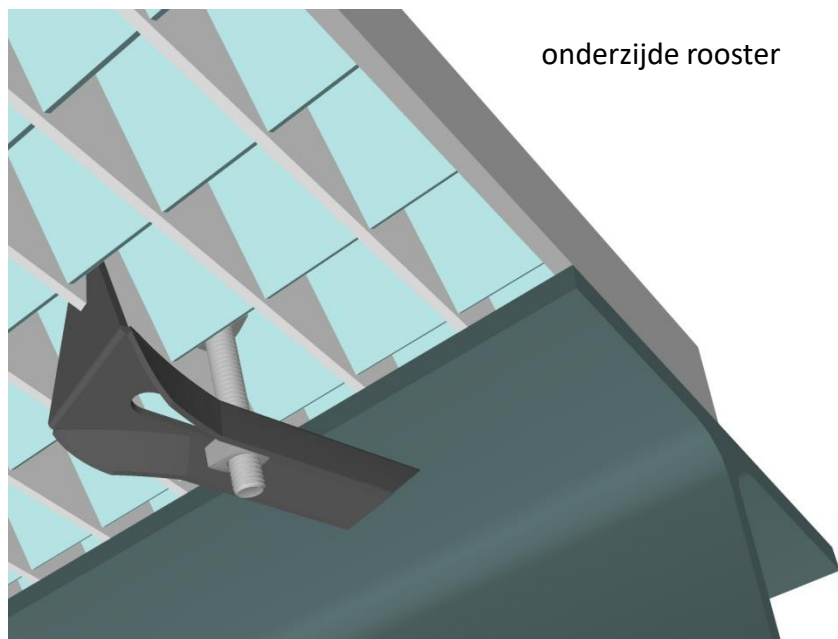

Productomschrijving Type 30:

Type: Lamellenrooster
Maas: n.v.t.
Materiaal: St235JR

Zadel: lamel
Kikker: lamel

Inbusbout: M8
Vierkant moer: M8

bovenzijde rooster

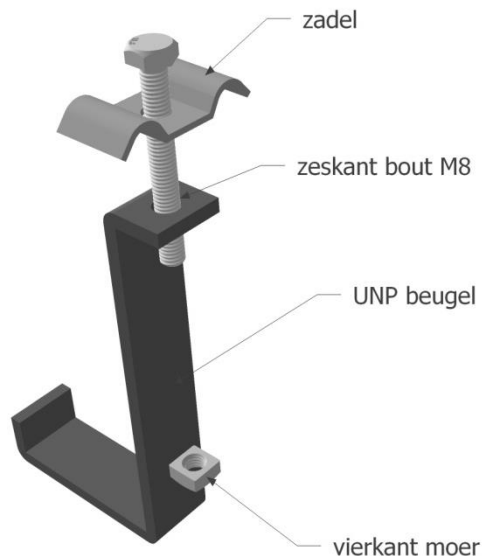
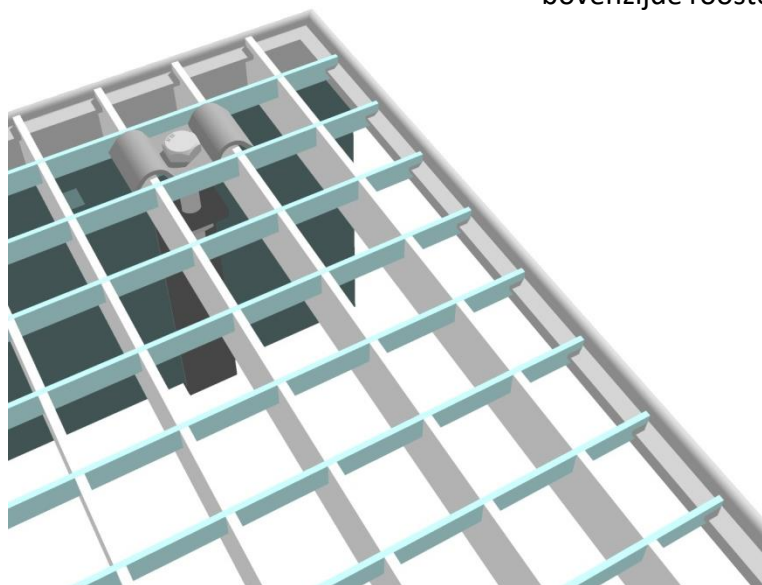

onderzijde rooster

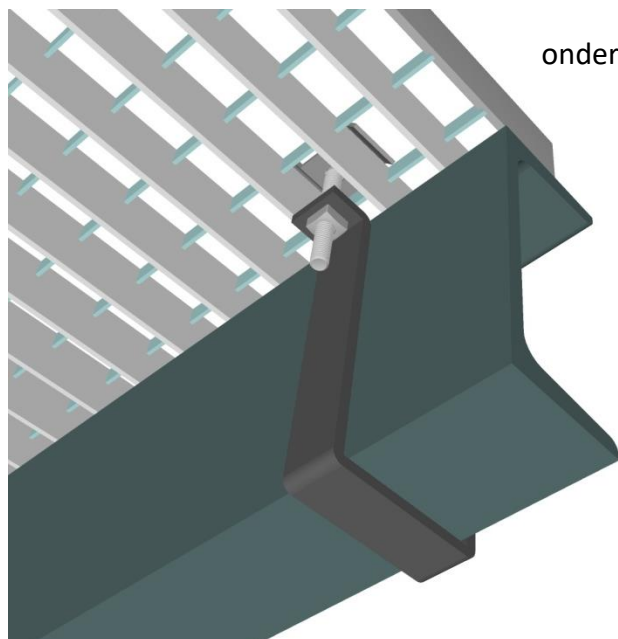

Productomschrijving UNP beugel:

Type: Persrooster
Maas: n.v.t.
Materiaal: St235JR

Zadel: afhankelijk van de maas Zeskant bout : M8
UNP beugel: afhankelijk van UNP Vierkant moer: M8

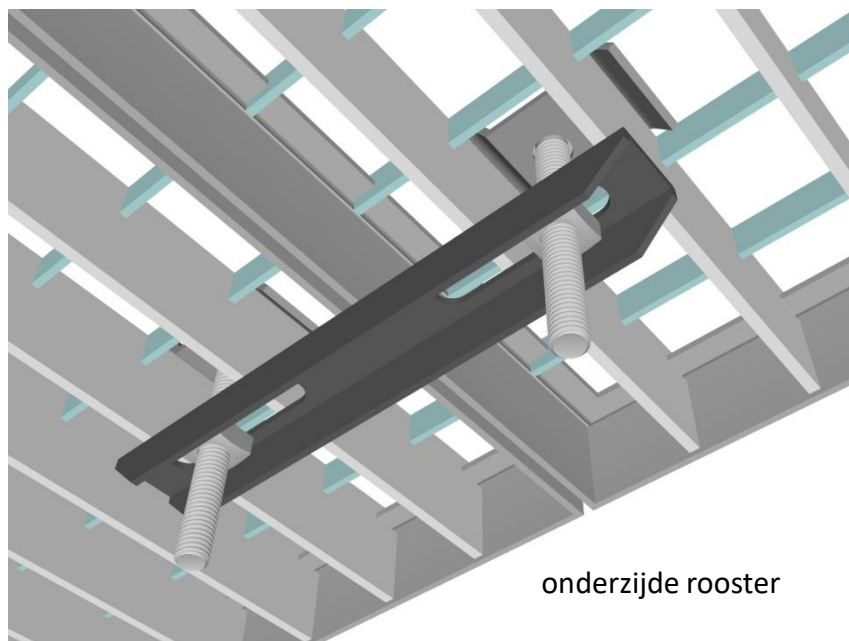
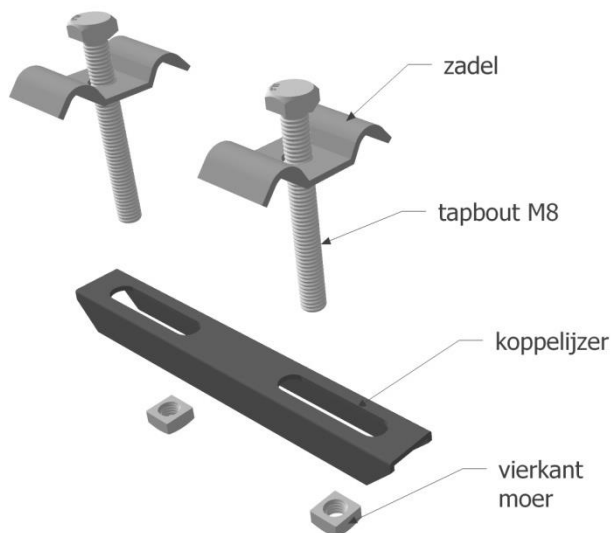
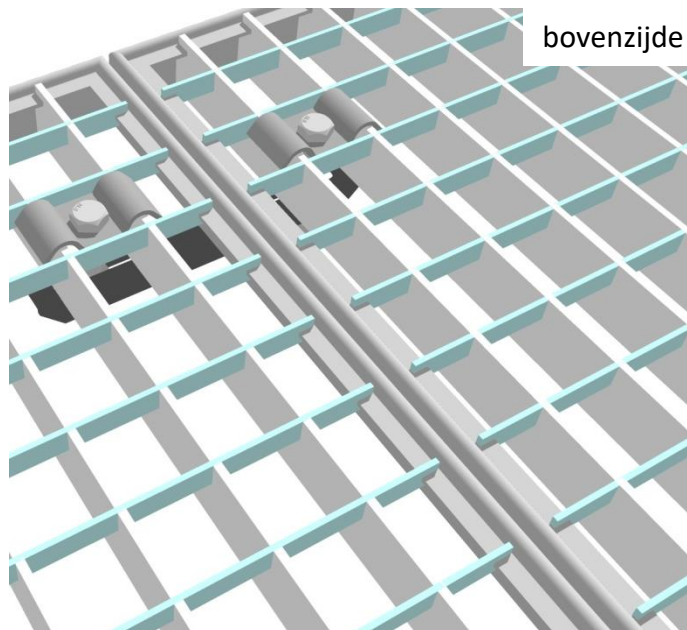

Productomschrijving :

Type: Persrooster
Maas: n.v.t
Materiaal: St235JR

Zadel: afhankelijk van maas
Kikker: afhankelijk van maas

Zeskant bouten : M8
Vierkant moeren: M8

Persrooster met ingelaste plaatjes

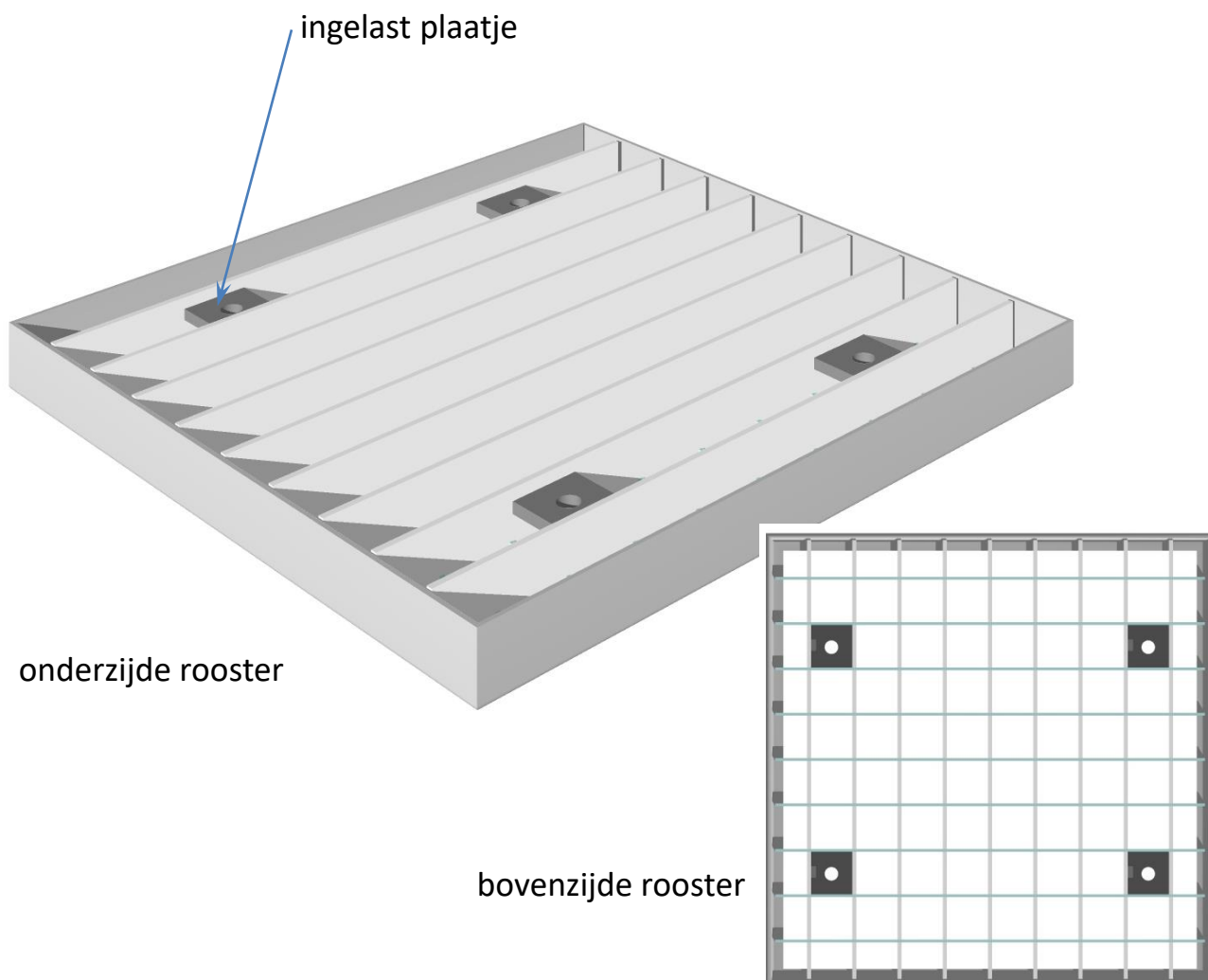

Productomschrijving:

Persrooster met ingelaste plaatjes

Rand: T profiel / vlakke rand
Materiaal: St235JR / aluminium / RVS